

FEATURES

- High breakdown voltage to 1200V for improved reliability
- Trench-Stop Technology offering :
 - very tight parameter distribution
 - high ruggedness, temperature stable behavior
 - Short circuit withstand time – 10μs
 - High ruggedness, temperature stable
 - Low $V_{CE(SAT)}$
 - Easy parallel switching capability due to positive temperature coefficient in $V_{CE(SAT)}$
- Enhanced avalanche capability
- Automotive AEC-Q101 qualified

V_{CE}	1200	V
I_C	40	A
$V_{CE(SAT)} I_C=40A$	1.7	V

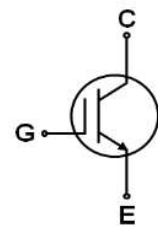

APPLICATION

- Frequency Converters
- PTC heater
- Motor Drive
- Specified application conditions

Product	Package	Packaging
AU40N120T1	TO247	Tube

Maximum Ratings

Parameter	Symbol	Value	Unit
Collector-Emitter Breakdown Voltage	V_{CE}	1200	V
DC collector current, limited by T_{jmax} $T_C = 25^\circ\text{C}$ $T_C = 100^\circ\text{C}$	I_C	80 40	A
Continuous Gate-emitter voltage	V_{GE}	± 20	V
Transient Gate-emitter voltage	V_{GE}	± 30	V
Turn off safe operating area $V_{CE} \leq 1200\text{V}$, $T_j \leq 150^\circ\text{C}$	-	160	A
Pulsed Collector Current, $V_{GE} = 15\text{V}$, t_p limited by T_{jmax}	I_{CM}	160	A
Short Circuit Withstand Time, $V_{GE} = 15\text{V}$, $V_{CE} \leq 600\text{V}$	T_{sc}	10	μs
Power dissipation, $T_j = 25^\circ\text{C}$	P_{tot}	416	W
Operating junction temperature	T_j	-40...+150	$^\circ\text{C}$
Storage temperature	T_s	-55...+150	$^\circ\text{C}$
Soldering temperature, wave soldering 1.6mm (0.063in.) from case for 10s	-	260	$^\circ\text{C}$

Thermal Resistance

Parameter	Symbol	Max. Value	Unit
IGBT thermal resistance, junction - case	$R_{\theta(j-c)}$	0.3	K/W
Diode thermal resistance, junction - case	$R_{\theta(j-c)}$	0.6	K/W
Thermal resistance, junction - ambient	$R_{\theta(j-a)}$	40	K/W

Electrical Characteristics of the IGBT ($T_j = 25^\circ\text{C}$ unless otherwise specified) :

Parameter	Symbol	Conditions	Min	Typ	Max	Unit
Static						
Collector-Emitter breakdown voltage	BV_{CES} ①	$V_{GE}=0V, I_C=250\mu A$	1200	1300	-	V
Gate threshold voltage	$V_{GE(th)}$	$V_{GE}=V_{CE}, I_C=250\mu A$	5.1	5.8	6.4	V
Collector-Emitter Saturation voltage	$V_{CE(sat)}$	$V_{GE}=15V, I_C=40A$ $T_j = 25^\circ\text{C}$ $T_j = 150^\circ\text{C}$	- -	1.7 2.1	2.1 -	V
Zero gate voltage collector current	I_{CES}	$V_{CE} = 1200V, V_{GE} = 0V$ $T_j = 25^\circ\text{C}$ $T_j = 150^\circ\text{C}$	- -	- -	10 2500	μA
Gate-emitter leakage current	I_{GES}	$V_{CE} = 0V, V_{GE} = \pm 20V$	-	-	100	nA
Transconductance	g_{fs}	$V_{CE}=20V, I_C=15A$	-	15	-	S

Parameter	Symbol	Conditions	Min	Typ	Max	Unit
Dynamic						
Input capacitance	C_{ies}	$V_{CE} = 25V, V_{GE} = 0V,$ $f = 1\text{MHz}$	-	4400	-	pF
Output capacitance	C_{oes}		-	180	-	
Reverse transfer capacitance	C_{res}		-	100	-	
Gate charge	Q_G	$V_{CC} = 960V, I_C = 40A,$ $V_{GE} = 15V$	-	270	-	nC
Short circuit collector current	$I_{C(SC)}$	$V_{GE}=15V, t_{sc}\leq 10\mu s$ $V_{CC}=600V,$ $T_{j, start}=25^\circ\text{C}$	-	240	-	A

Note:

 ① BV_{ces} testing without filter could damage the device. BV_{ces} is guaranteed by $I_{ces}@1200V$ test.

Switching Characteristic, Inductive Load

Parameter	Symbol	Conditions	Min	Typ	Max	Unit
Dynamic , at $T_j = 25^\circ \text{C}$						
Turn-on delay time	$t_{d(on)}$	$V_{CC} = 600\text{V}, I_C = 40\text{A},$ $V_{GE} = 0/15\text{V},$ $R_g = 12\Omega$	-	55	-	ns
Rise time	t_r		-	20	-	ns
Turn-on energy	E_{on}		-	2.4	-	mJ
Turn-off delay time	$t_{d(off)}$		-	230	-	ns
Fall time	t_f		-	100	-	ns
Turn-off energy	E_{off}		-	1.5	-	mJ

Fig. 1 FBSOA characteristics

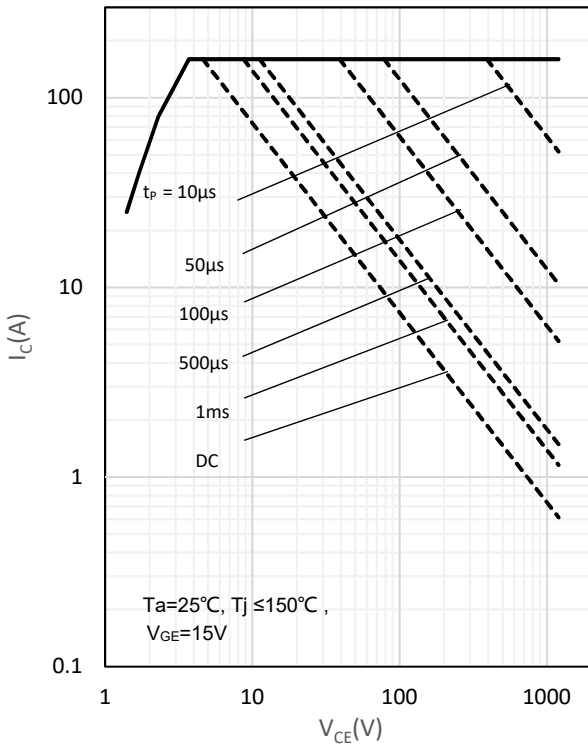

Fig. 2 Load Current vs. Frequency

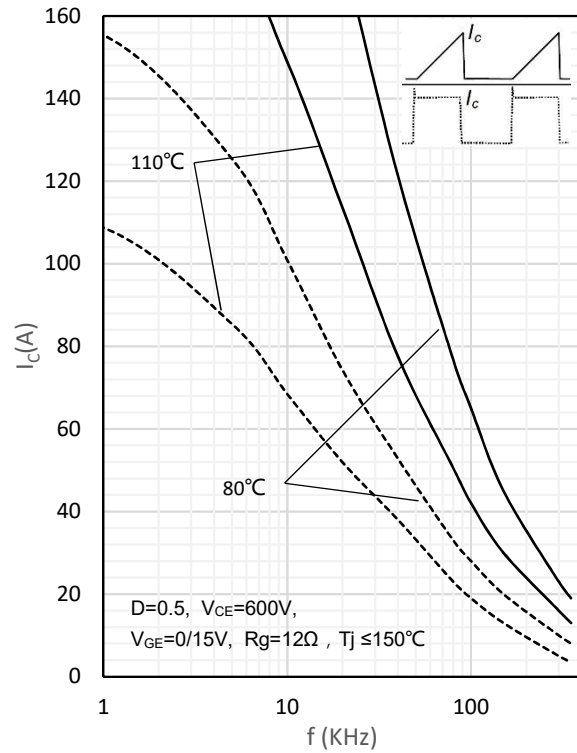

Fig. 3 Power dissipation as a function of T_C

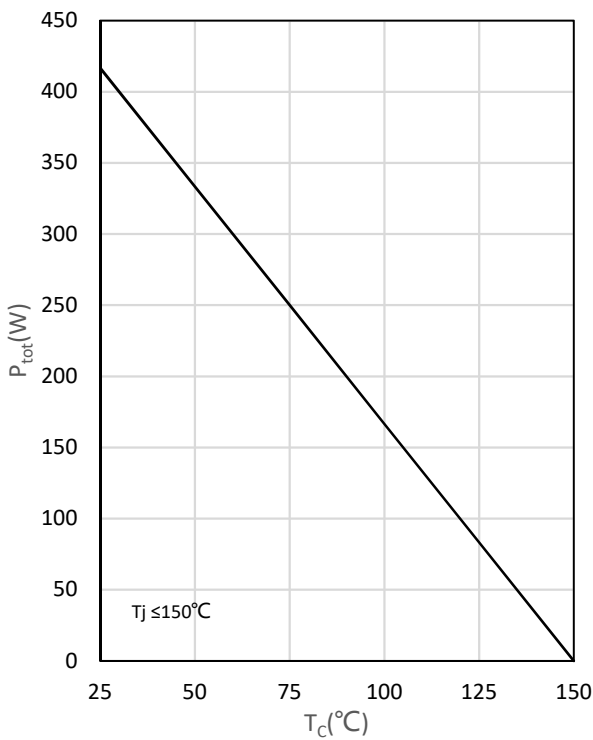

Fig. 4 Short circuit time and current vs. V_{GE}

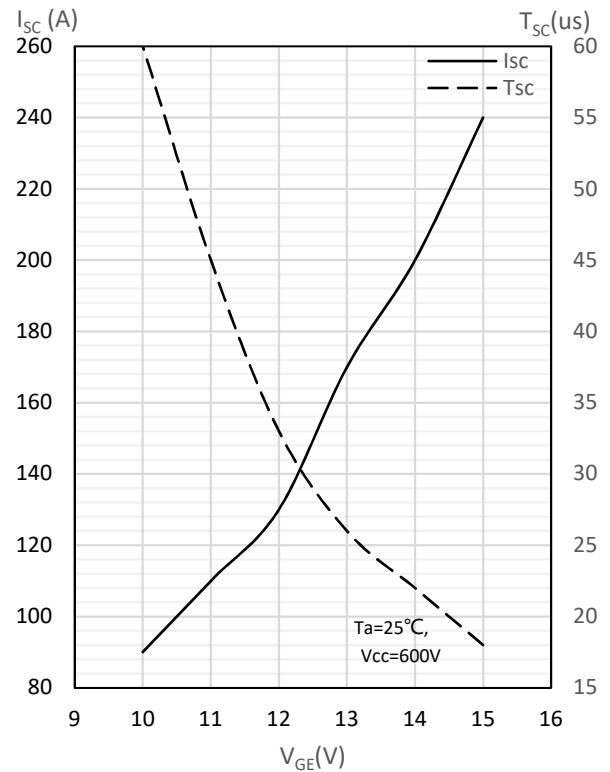

Fig. 5 Output characteristics

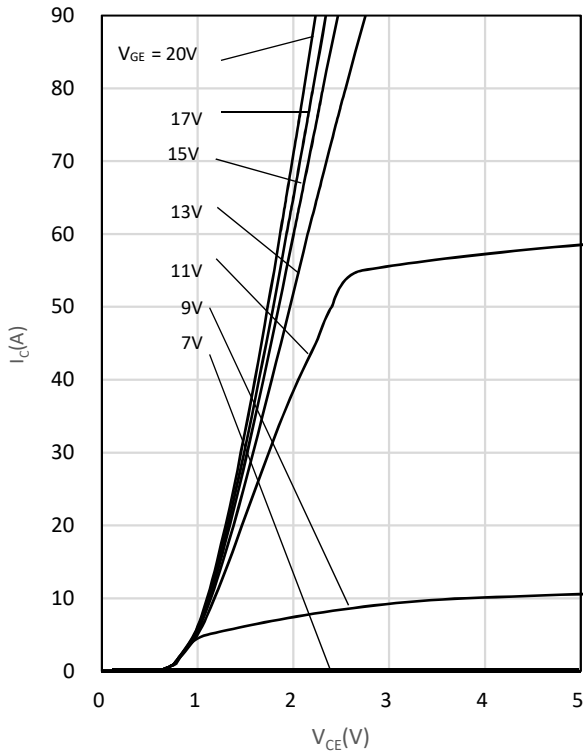

Fig. 6 Saturation voltage characteristics

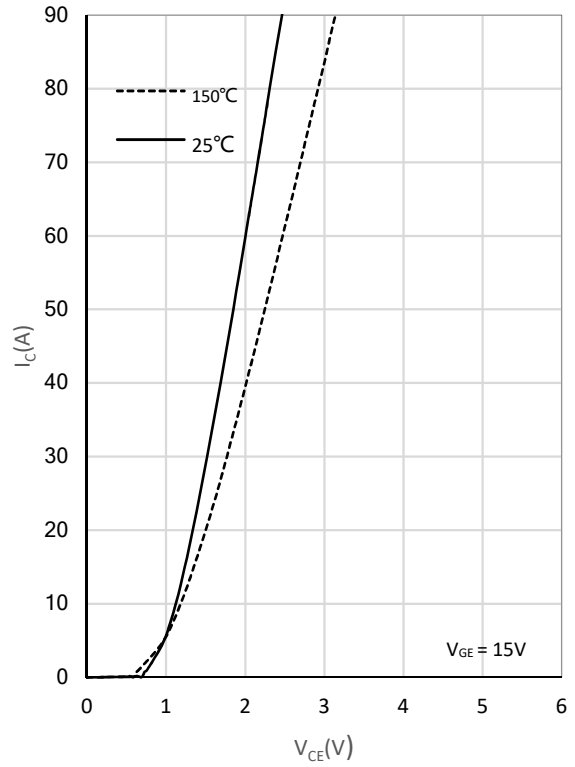

Fig. 7 Switching times vs. gate resistor

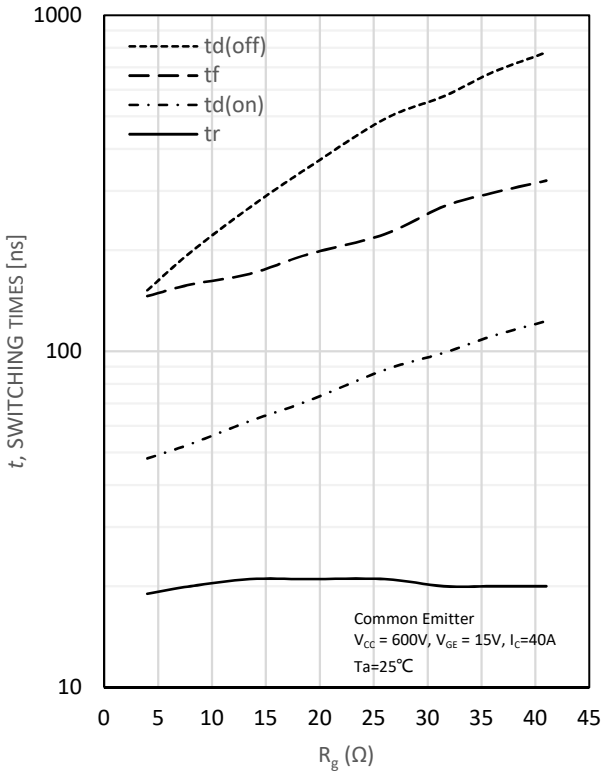

Fig. 8 Switching times vs. collector current

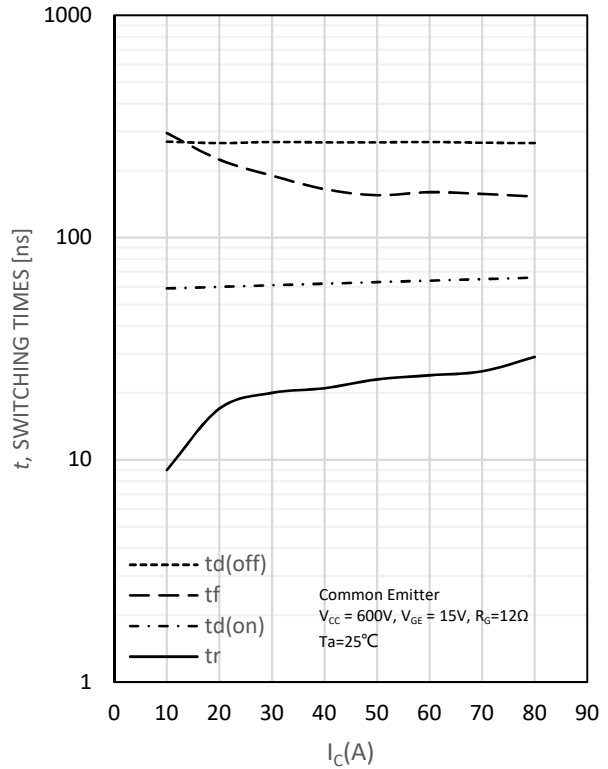

Fig. 9 Switching loss vs. gate resistor

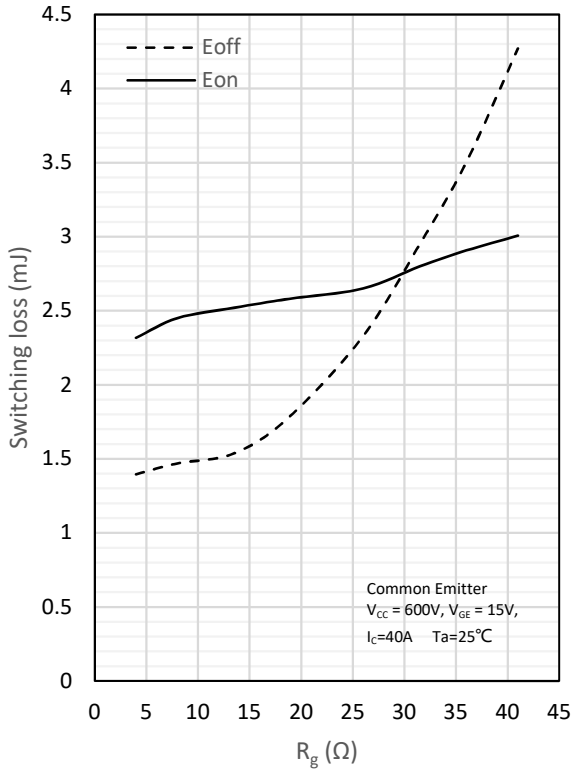

Fig. 10 Switching loss vs. collector current

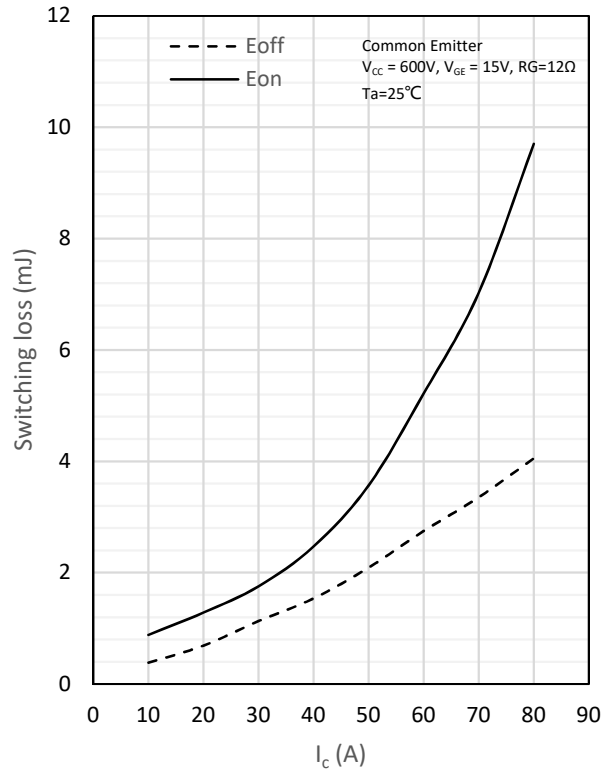

Fig. 11 Gate charge characteristics

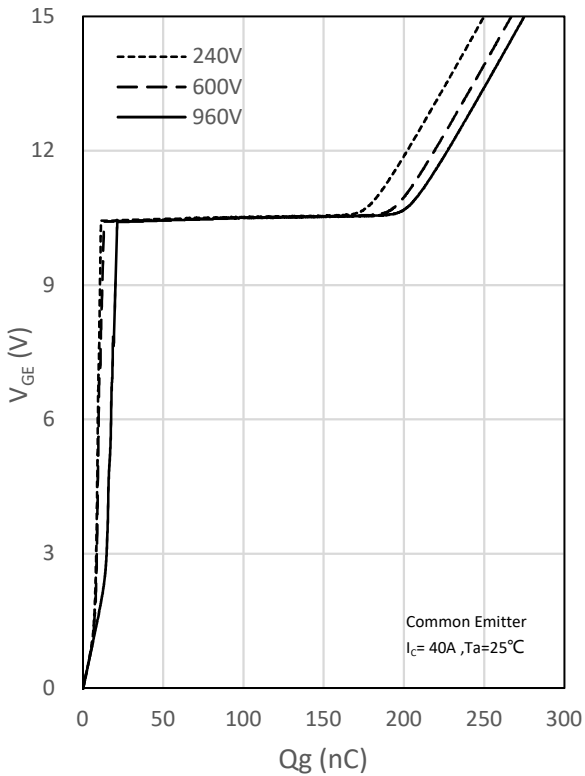
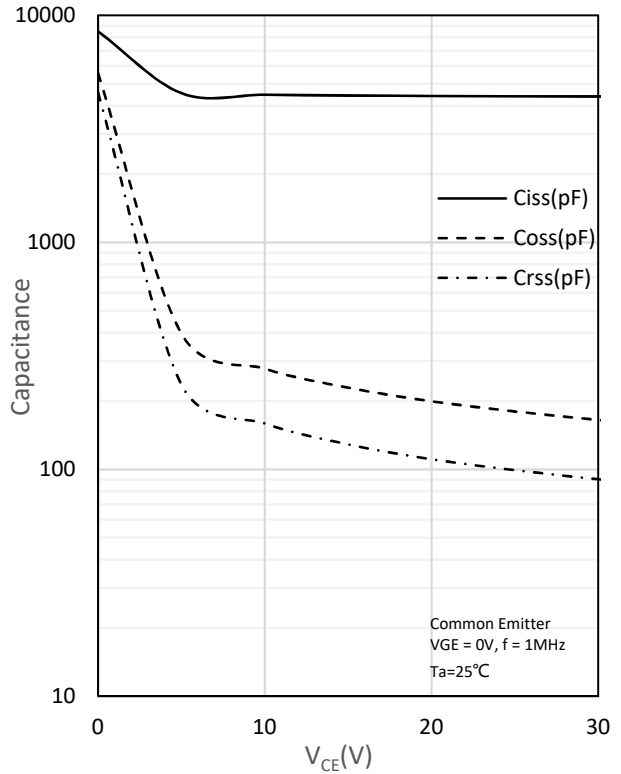
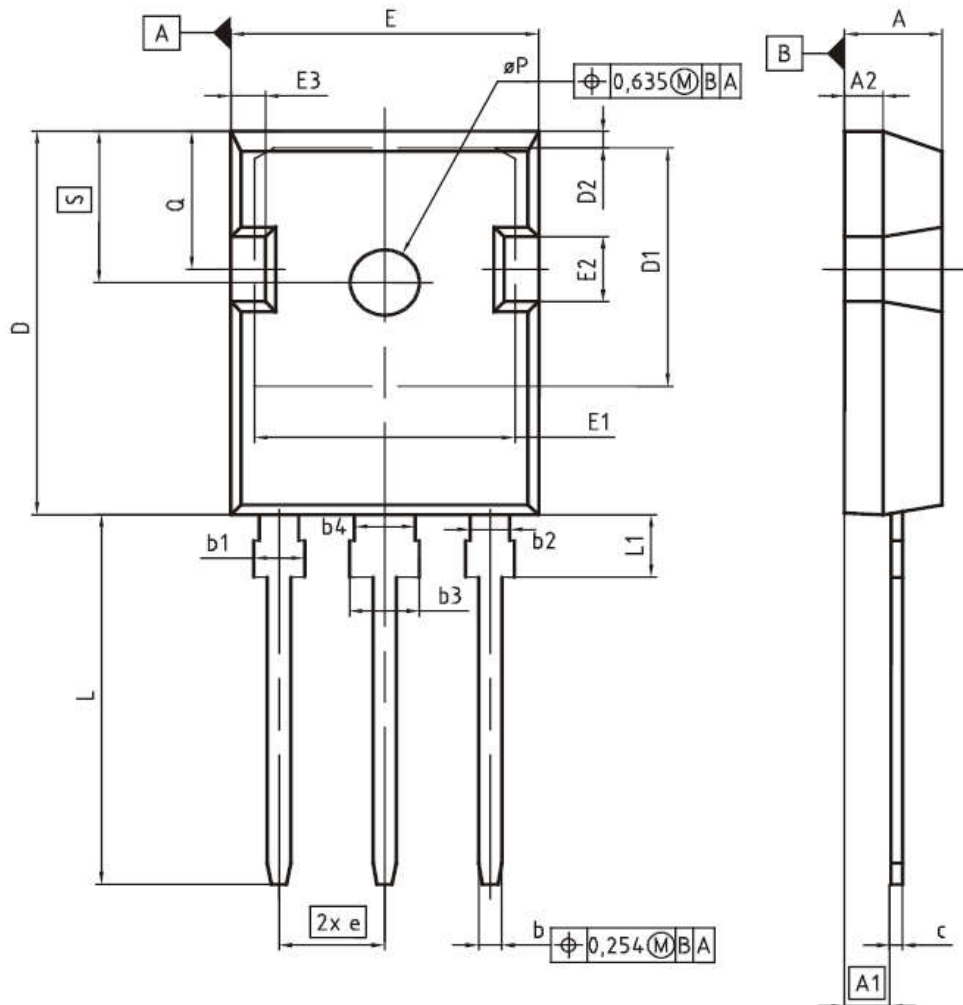

Fig. 12 Capacitance characteristics



PG-TO247-3

DIM	MILLIMETERS		INCHES	
	MIN	MAX	MIN	MAX
A	4.83	5.21	0.190	0.205
A1	2.27	2.54	0.089	0.100
A2	1.85	2.16	0.073	0.085
b	1.07	1.33	0.042	0.052
b1	1.90	2.41	0.075	0.095
b2	1.90	2.16	0.075	0.085
b3	2.87	3.38	0.113	0.133
b4	2.87	3.13	0.113	0.123
c	0.55	0.68	0.022	0.027
D	20.80	21.10	0.819	0.831
D1	16.25	17.65	0.640	0.695
D2	0.95	1.35	0.037	0.053
E	15.70	16.13	0.618	0.635
E1	13.10	14.15	0.516	0.557
E2	3.68	5.10	0.145	0.201
E3	1.00	2.60	0.039	0.102
e	5.44 (BSC)		0.214 (BSC)	
N	3		3	
L	19.80	20.32	0.780	0.800
L1	4.10	4.47	0.161	0.176
ϕP	3.50	3.70	0.138	0.146
Q	5.49	6.00	0.216	0.236
S	6.04	6.30	0.238	0.248